

8900 EMR (WITH DETECTOR)



GENERAL DESCRIPTION

Each 8900 EMR series unit contains a door closer, hold open electromagnet and smoke detector. The unit can be used as a single installation or as a series of singles powered from one or more power supplies. When a series of 8900 EMR units are wired together in a run, groups of up to 5 units may be interconnected. Interconnection is accomplished through terminals #4 and #15 and results in all units alarming when any one of them senses smoke. In turn, all associated hold open electromagnets are de-energized. Within any run of detected units, it is permissible to form as many interconnected groups as the total power supply amperage will allow; but, again no more than 5 units can be interconnected together.

Any detected 8900 EMR series unit can be connected to an auxiliary EMF non-detected unit, or remote detector, or both. It can be a single installation or part of any of the multiple arrangements described above. An auxiliary unit (double door applications) is a companion to the main unit, and its electromagnet de-energizes along with the main unit. A remote open area detector sensing smoke alarms the 8900 EMR to which it is connected and any other 8900 EMR to which it is interconnected.

Single installations or groups of installations can be connected to the alarm initiation circuit of a compatible UL/ULC listed fire alarm control unit in 4-wire or 6-wire configurations.

Additional functions are provided to separately power the hold open electromagnets directly from the alarm control panel as well as connections for a remote alarm indicator lamp.

INSTALLATION

1. Read entire instruction sheet prior to installation and refer to NFPA 72E. Standards may be obtained from THE NATIONAL FIRE PROTECTION ASSOCIATION, Batterymarch Park, Quincy, MA 02269.
2. Reference unit carton for unit mounting type.
3. Prepare door and frame for fasteners using the appropriate template. Mark, drill, and tap holes as indicated. If surface wiring is used, omit 7/8" hole for wire access.

NOTE:

If installing the optional bypass switch, install assembly on the end of track as shown. Fasten track to door frame with the screw provided (T mount uses a cylindrical spacer). Fasten the end cap assembly with metal or wood screws provided. Connect the switch with wire nuts and slide the cover in place. For T mount, place end cap in extension piece and fasten to frame with screw provided.

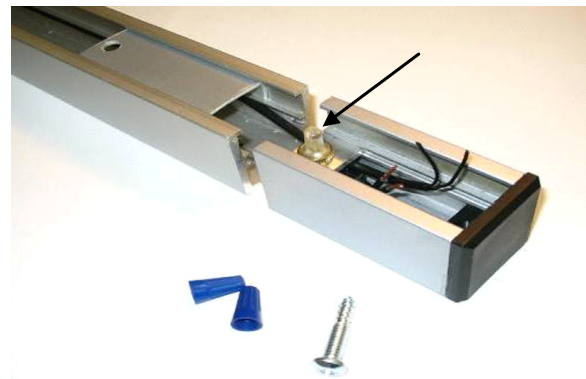

Optional Bypass Switch - PT Mount

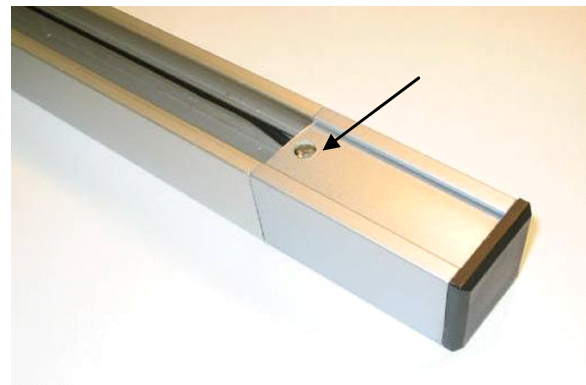

Optional Track Bypass Switch - T Mount

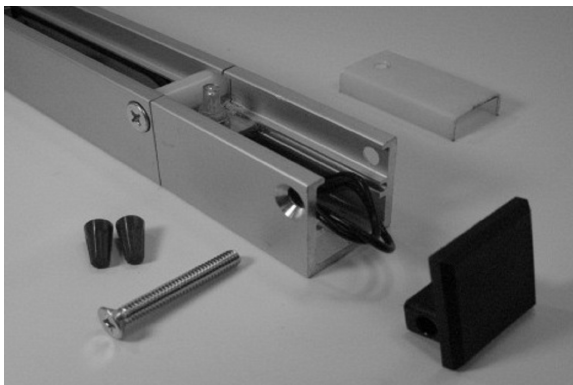

INSPK NO. 08279530 Rev 08/13

4 Install track to frame.

8900T and 8900DE

Install with detector cut out toward latch edge of door using (2) 1/4-20 x 2" metal or (2) No. 14 x 2-3/4" wood screws.

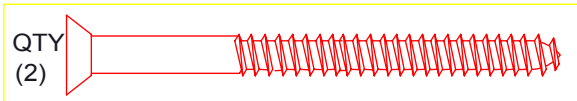
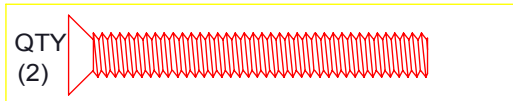
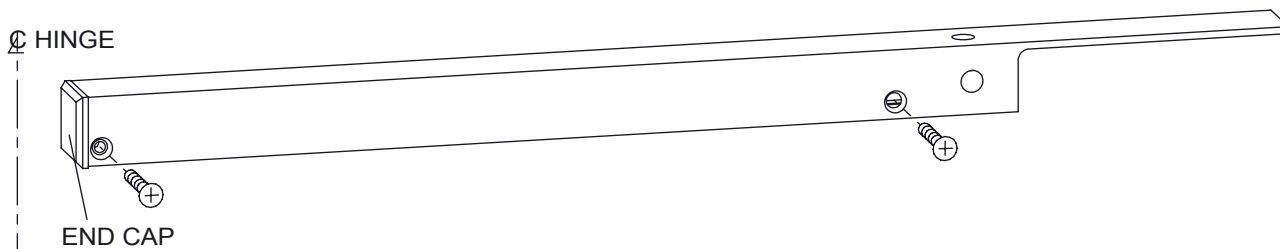

Install with detector cutout toward hinge edge of door using (2) 1/4-20 x 2" metal or (2) No. 14 x 2-3/4" wood screws.

8900PT

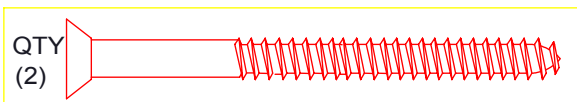
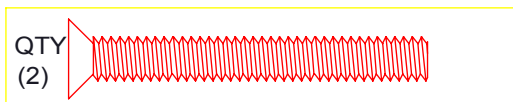
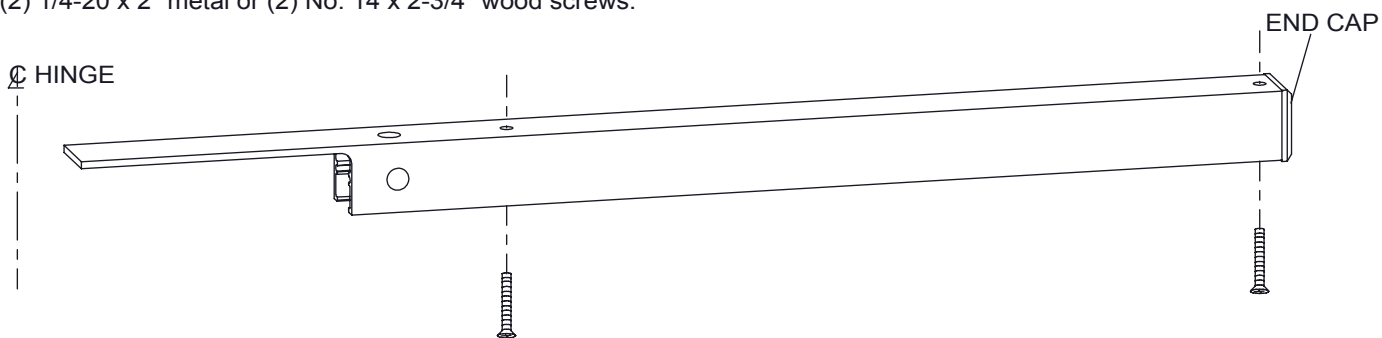

5 Install detector.
Slide detector slot under standoff and attach with (4) screws.

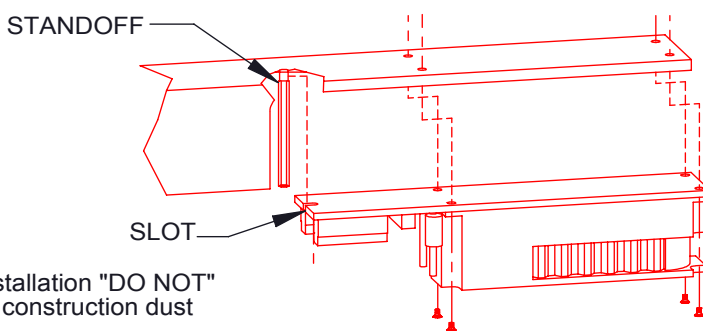

NOTE:
If construction is still being completed near detector installation "DO NOT" install detector at this time or protect the detector from construction dust contaminants.

6 Remove (1) wire access plug according to the installation type.

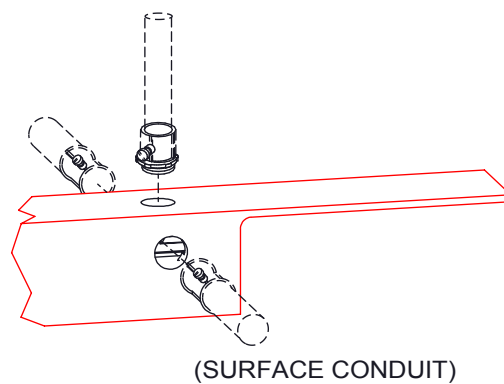
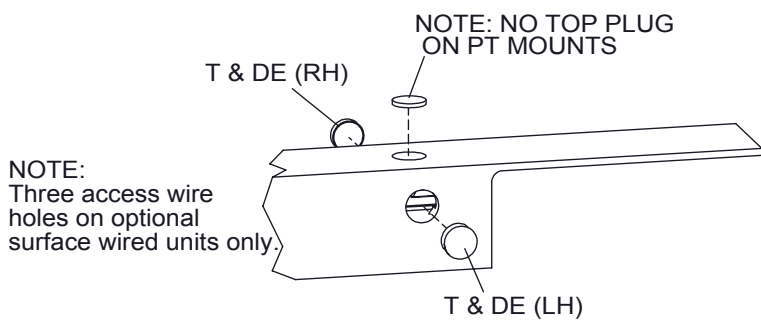

7

Install closer to door.

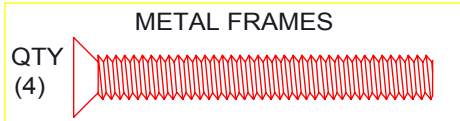

8900T AND 8900DE

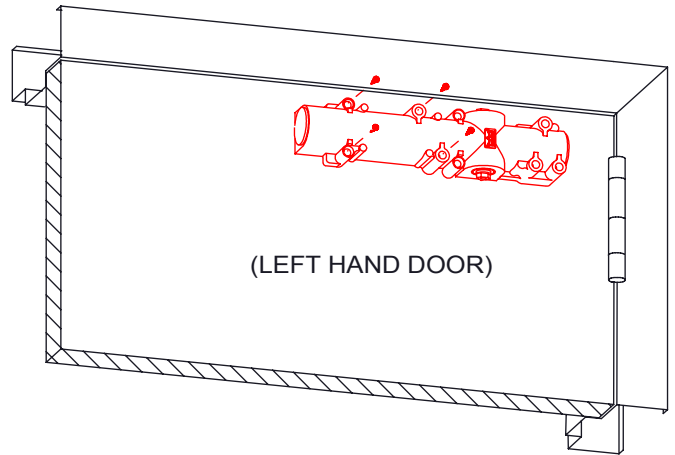
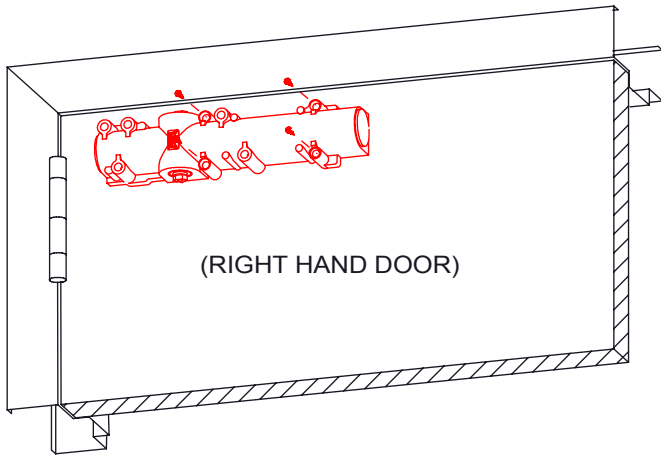

8900PT

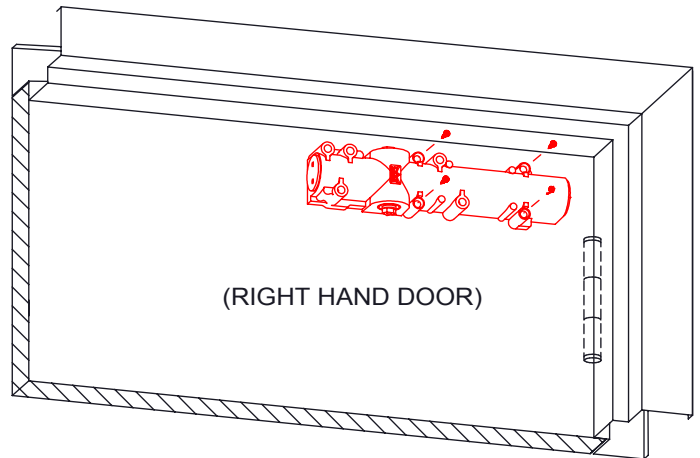
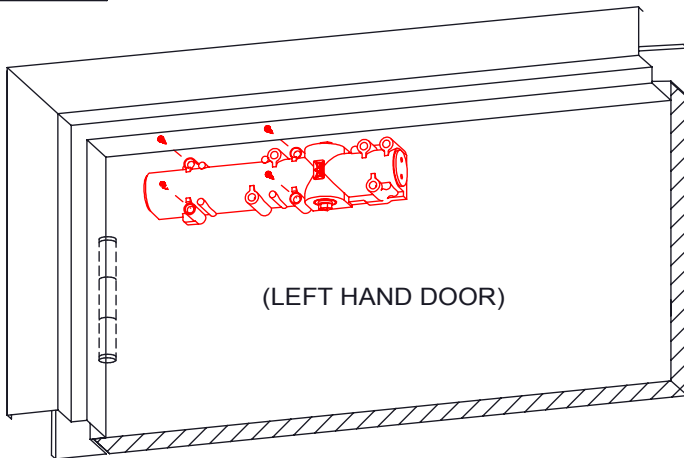

8

Attach main arm to door closer.

Place arm on top pinion as shown @ 45° angle. Secure with pinion screw.

8900T

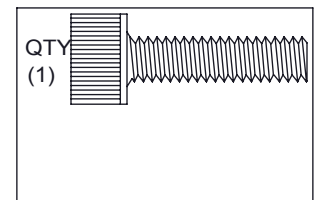
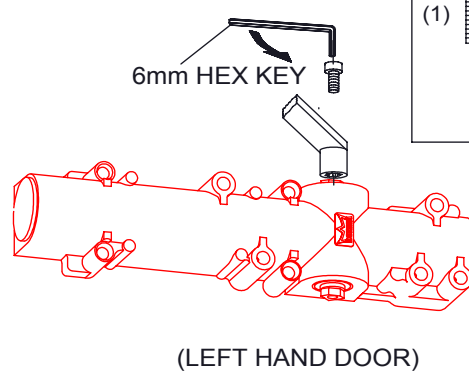
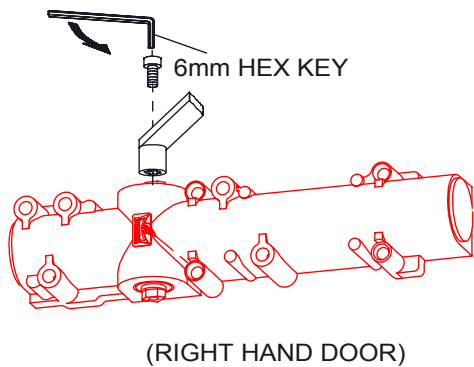

8905DE

Attach main arm to door closer.

Place arm on top pinion as shown @ 45° angle. Secure with pinion screw.

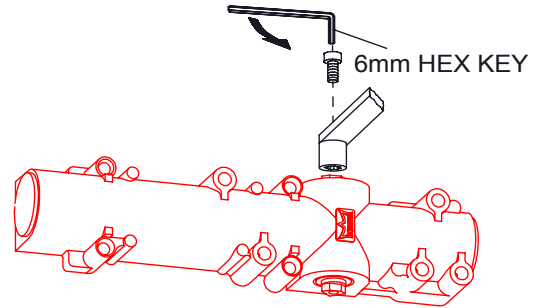
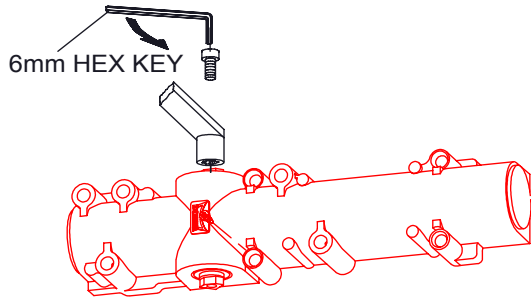

8900PT

With door in closed position, rotate spindle 45° with wrench. Place arm on spindle. Open door and secure with pinion screw.

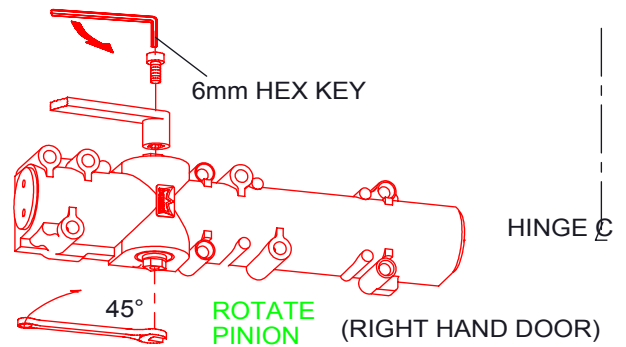
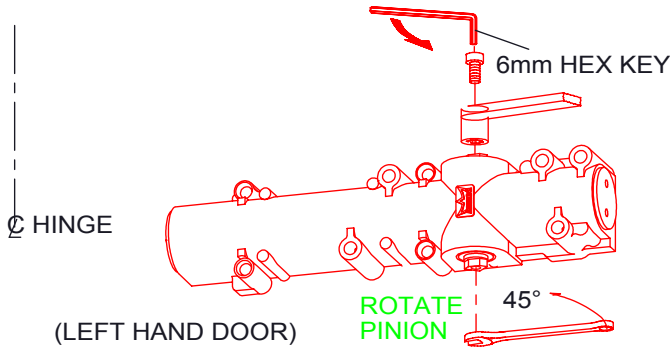

9 Attach arm to slide shoe. Use 3/16 inch hex head wrench.

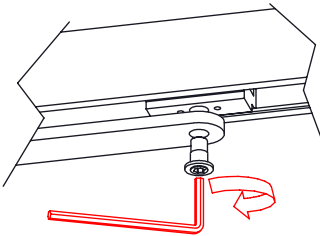

10 Adjust spring tension, if required, using a 1/4" wrench.

NOTE: 8916 supplied with size 3 spring setting.
8956 supplied with size 6 setting.



CRITICAL

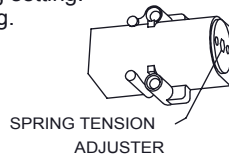

Adjust according to chart.

CLOSER TYPE	DOOR WIDTH	FULL TURNS OF SPRING ADJUSTER	SPRING SIZE
	INTERIOR		
8916	2'-6"	0	4
	3'-0"	+8	5
	3'-6"	+16	6
8956	3'-6"	0	6
	4'-0"	+6	6+

ULC LABELED UNITS ONLY

ADJUST SPRING TENSION ACCORDING TO THE FOLLOWING CHART.

CLOSER TYPE	MAX. DOOR WEIGHT	SPRING SIZE	FULL TURNS OF SPRING ADJUSTING NUT
8916	125	4	0
	150	5	+8
	200	6	+16
8956	200	6	0
	250	6+	+6

NOTE: DO NOT ADJUST SPRING LOWER THAN SIZE 3

11 Adjust sweep, latch and backcheck valves.

CAUTION: DO NOT REMOVE VALVES.

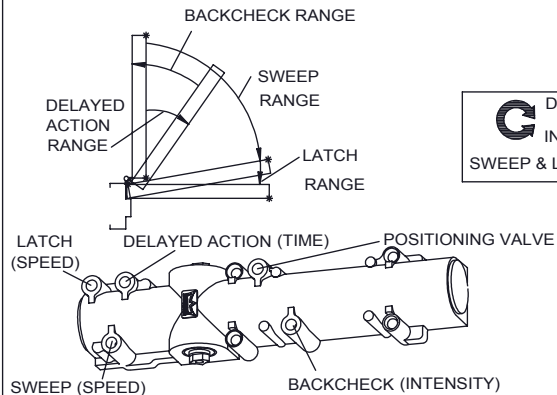

INCREASE
DECREASE
BACKCHECK OR DELAYED ACTION

NOTE: DELAYED ACTION IS AN OPTIONAL FEATURE.

The following six pages contain wiring options. Wire the units according to building and system requirements. Observe all applicable codes.

ELECTRICAL SPECIFICATIONS

Voltage input:	24 VDC +10% - 15% 24 VAC +10% - 15%
	NOTE: 120 Volt applications require optional external transformer.
Maximum input current:	@24 VDC- 161 mA (1 solenoid), 310 mA (2 solenoids) @24 VAC- 161 mA (1 solenoid), 310 mA (2 solenoids)
	NOTE: Excludes accessories
Maximum output to Remote Alarm Indicator Lamp:	300 mA
Contact ratings:	Alarm and or accessory contacts- 1.25 A at 24 VDC or .3 A at 120 VAC resistive, maximum. Trouble contacts- 500 mA at 24VDC resistive maximum .

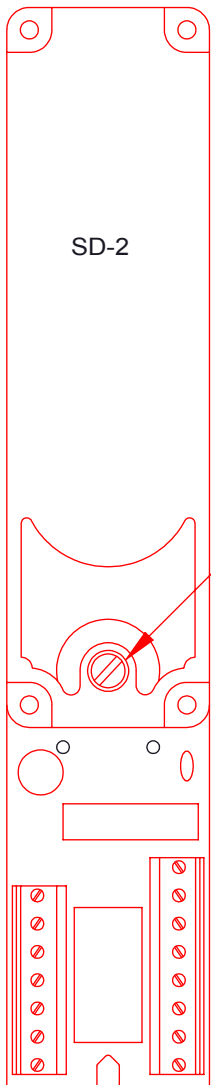

DETECTOR CONNECTION LIST

<u>FUNCTION</u>	<u>TERMINAL</u>
AC/DC 24V INPUT	3, 14
ALARM CONTACTS (NORMALLY OPEN)	1, 2
ELECTROMAGNET	6, 9
REMOTE ALARM INDICATOR LAMP +	8
REMOTE ALARM INDICATOR LAMP -	7
INTERCONNECT +	15
INTERCONNECT -	4
TROUBLE CONTACTS (NORMALLY CLOSED)	5,13
24 VDC OUTPUT (UNFILTERED) +	10

IF JUMPER WIRE J11/J12 IS CUT,
TERMINALS 8, 9 AND 10 ARE
CHANGED TO FORM C RELAY
CONTACTS, RAIL OUTPUT IS
LOST, AND HOLD OPEN ELECTROMAGNETS
MUST BE POWERED FROM A SEPARATE
SOURCE. CONSULT FACTORY
IF REMOTE DETECTORS ARE USED
IN THIS APPLICATION.

COM 10
N.C. 9
N.O. 8

POWER SUPPLY Insulate all connections. Observe all local codes.

120 VAC, 50/60 HZ

120 VAC, 50/60 HZ: Connect the 120 VAC incoming voltage wires to the primary wires of the transformer. Connect the secondary transformer wires to terminals #3 and #14 of the detector module. This connection is not polarity dependent.

NOTE: FOR ULC INSTALLATIONS, TRANSFORMER MUST INSTALL IN 4" X 4" ELECTRICAL BOX X 3" DEEP MINIMUM.

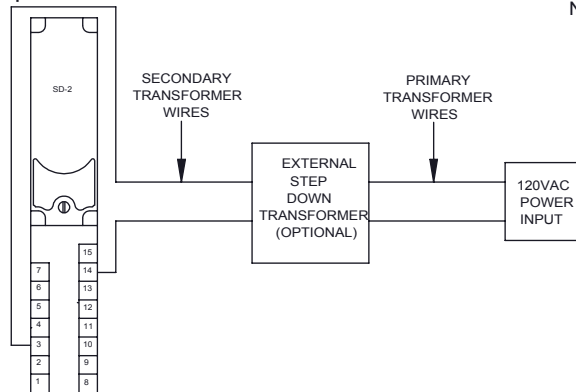

24V AC/DC

24V AC/DC NOTE: The step down transformer is not used in this connection. Connect 24V AC/DC power to terminals #3 and #14 on the detectors. These connections are not polarity dependent. If the unit is connected to a second unit, connect terminal #3 of the first unit to terminal #3 of the second unit and connect terminal #14 of the first unit to terminal #14 of the second unit. Continue this process for any subsequent units to be powered from the same power supply.

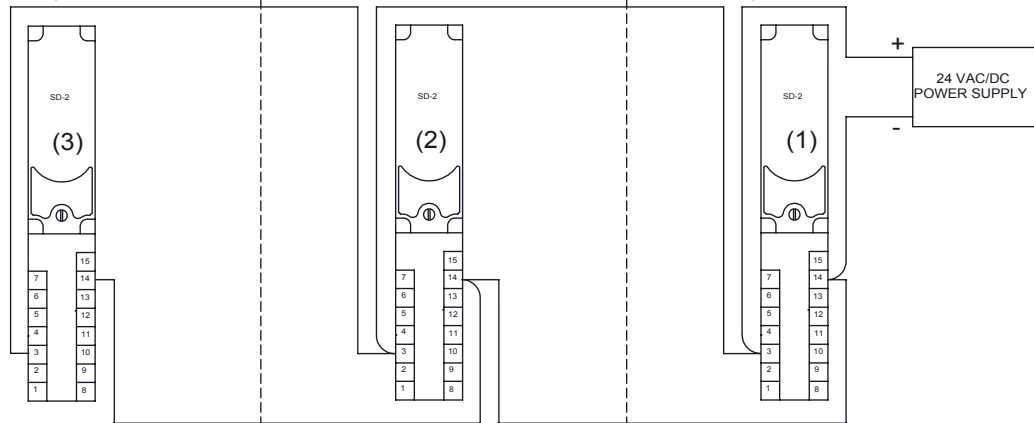

24V AC/DC WITH REMOTE DETECTORS

24V AC/DC WITH REMOTE DETECTORS NOTE: The step down transformer is not used in this connection. Perform wiring connections as illustrated below. Additional units are wired in the same manner as unit #2. Installations using a combination of SD-2 modules with and without remote area detectors can be wired accordingly by substituting the wiring diagram section from unit #1, #2, or #3 in step #3 above instead of unit #1, #2, or #3 below with remote detector. The vertical dashed lines indicate where one diagram would be exchanged for another.

NOTE: Input voltage must match detector voltage.

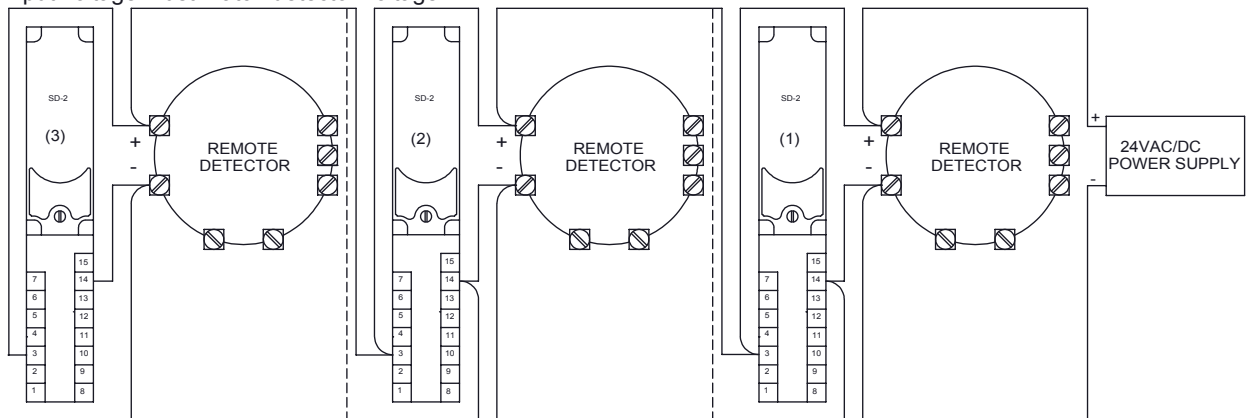

WIRE GAUGE

WIRE GAUGE: The maximum wire gauge for wiring the SD-2 detector module is #18 AWG. The method for determining wire gauge is given below. NOTE: A minimum of 20.4 VDC must be supplied to each solenoid in the run.

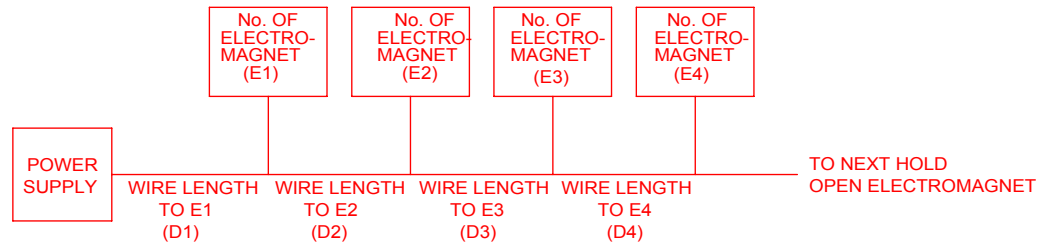

S1, S2, S3 etc. are the number of solenoids at each subsequent station. D1 is the distance from the power supply to the first solenoid station. D2, D3, D4 etc. are the distances from the previous solenoid station to the next solenoid station in the run. To determine the correct wire gauge multiply E1 times D1. Add that quantity to E2 times D2. Repeat the same procedure for each electromagnet to test the last unit in the run. Compare the quantity calculated to the chart below. The calculated value must be less than or equal to the value corresponding to the appropriate wire gauge.

10 GAUGE-11,788 12 GAUGE-7,407 14 GAUGE-4,669 16 GAUGE-2,997 18 GAUGE-1,843

The procedure described above can be expressed in the following equation: $(E1 \times D1) + (E2 \times D2) + (E3 \times D3) + \dots + (En \times Dn)$. The above values correspond to the wire gauge to be used. If the calculated value is 1,843 #18 AWG wire can be run and connected directly to the detector module. If the calculated value exceeds 1,843 larger wiring will be required. Since the detector will only accept #18 AWG wire, a wiring splice will be necessary as illustrated below.

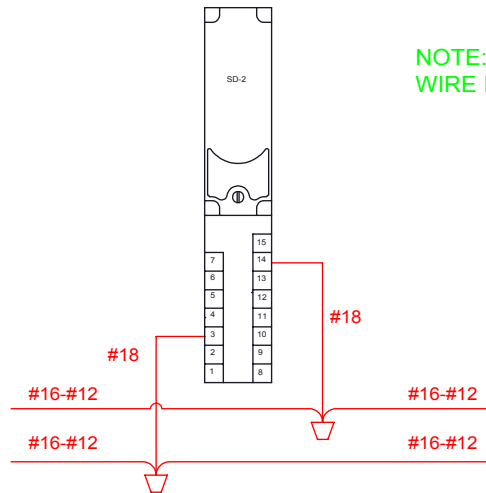

NOTE: FOR ULC INSTALLATIONS, 18 GAUGE WIRE IS REQUIRED TO DETECTOR

SD-2 DETECTOR TO MAIN SOLENOID CONNECTION

Strip approximately 1/4" of plastic insulation from the end of the two solenoid wires supplied. Connect one end each of the electromagnet wires to terminals 6 & 9 of the SD-2 detector as shown.

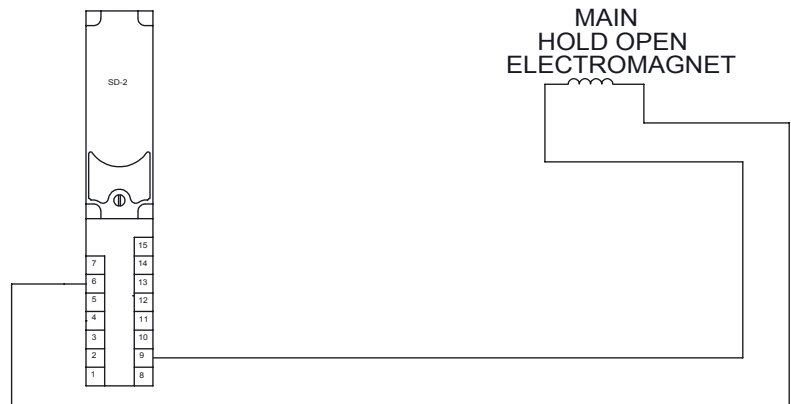

SD-2 DETECTOR TO AUXILIARY SOLENOID CONNECTION

NOTE: Make this connection the same time as the main hold open solenoid connection. Strip approximately 1/4" of plastic insulation from the ends of the wires. Connect auxiliary hold open solenoid wires to 9&6 of SD-2 detector.

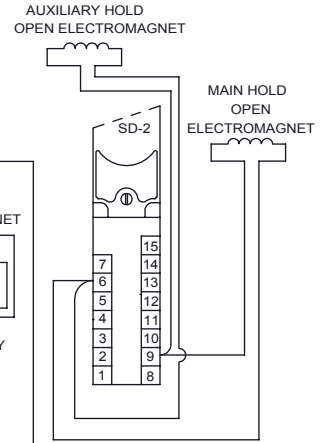

SOLENOID ATTACHMENT TO UL/ULC LISTED ALARM CONTROL PANEL

Some applications may require input power to the hold open electromagnet to be supplied through a UL/ULC listed alarm control panel so the hold open electromagnet functions separately from the internal detector module. This application requires the alarm contacts of the SD-2 detector and any remote detectors to be connected to the alarm contacts of the control panel. An alarm indication to the panel results in the loss of power to the hold open electromagnets in the related zone, which allows the doors to close. Wire main electromagnet to alarm control panel as illustrated.

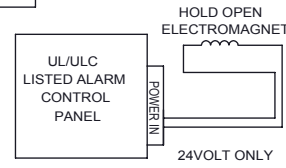

SD-2 DETECTOR INTERCONNECTION

1. Up to (5) SD-2 detectors, with or without connection to an auxiliary unit or remote area detector may be interconnected. This limitation applies only to interconnected units and assumes a power supply large enough to handle this load if the power supply is common to all units interconnected. Separate power supplies may be used for each SD-2 detector while permitting the units to be interconnected.

2a. For units without connection to remote detectors, connect terminal #15 (+) between the units to be interconnected. Connect terminal #4 (-) between the units to provide a common for the interconnection. Additional units are wired in the same manner as unit #2 but no more than five (5) units can be interconnected.

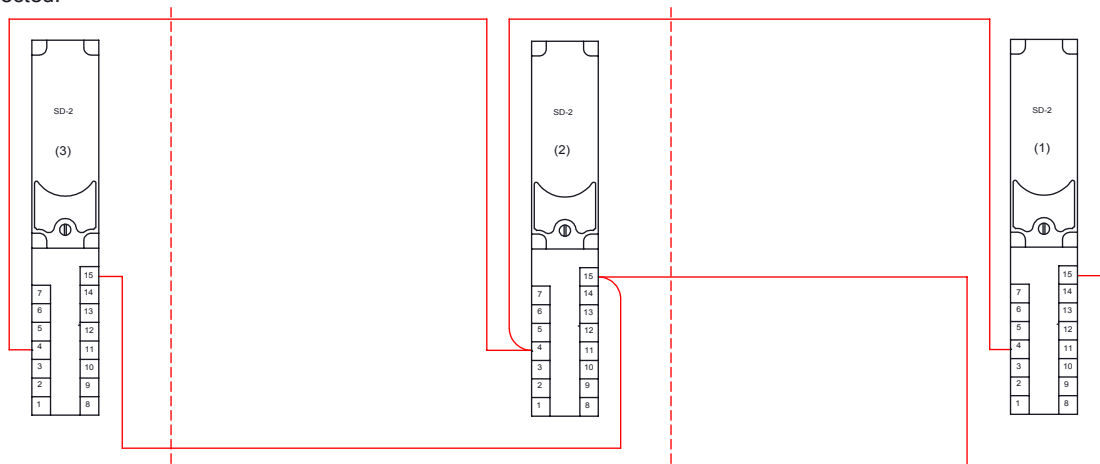

2b. For units used in conjunction with remote area detectors, complete wiring connections as illustrated below. Heed caution note in SD-2 DETECTOR TO REMOTE AREA DETECTOR section of instruction sheet. Additional units are wired in the same manner as unit #2 but no more than five (5) units can be interconnected. Installations using a combination of SD-2 detector modules with or without remote area detectors can be wired accordingly by substituting the wiring diagram from unit 1, 2, or 3 in step 2a. above for unit 1, 2, or 3 below. The vertical dashed lines indicate where one (1) diagram would be exchanged for another.

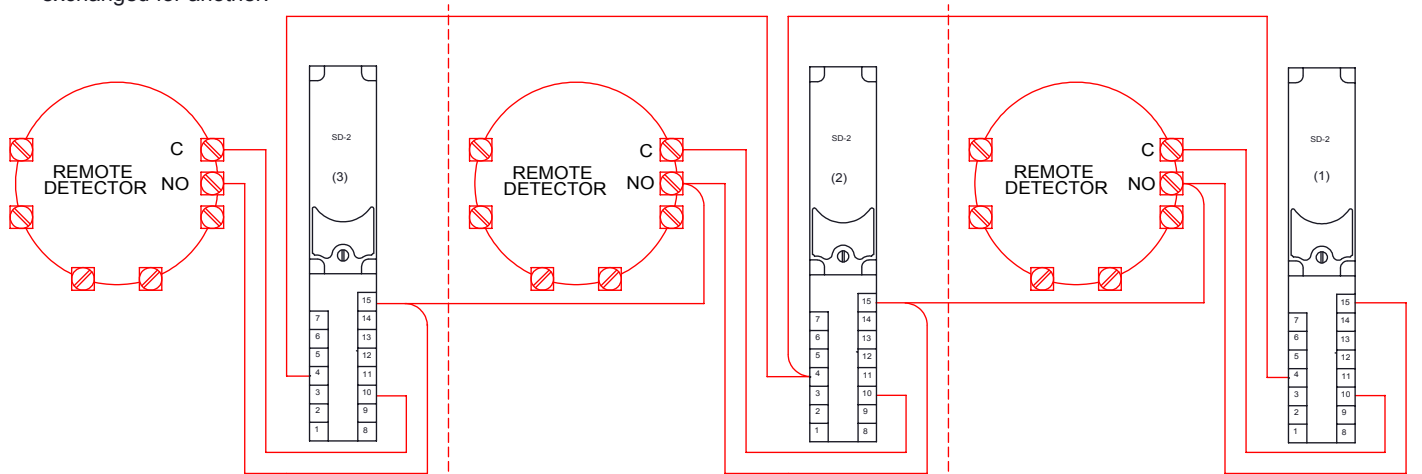

SD-2 DETECTOR TO REMOTE AREA DETECTOR

CAUTION: A remote open area detector can only be connected to a unit whose trouble relay contacts (#5 & #13) are connected in a circuit for the purpose of obtaining an audible trouble signal in the event of a circuit fault. In the event that the unit is used for releasing service only, the trouble contacts are connected to the trouble circuit of a UL/ULC listed alarm control panel. This condition is satisfied by the four (4) and six (6) wire supervisory connections in the alarm initiation wiring section. Perform wiring connections as illustrated below. **NOTE:** The SD-2 is wired as the E.O.L. (end of line) device for the remote detector. Therefore, it must act as the last item in the loop.

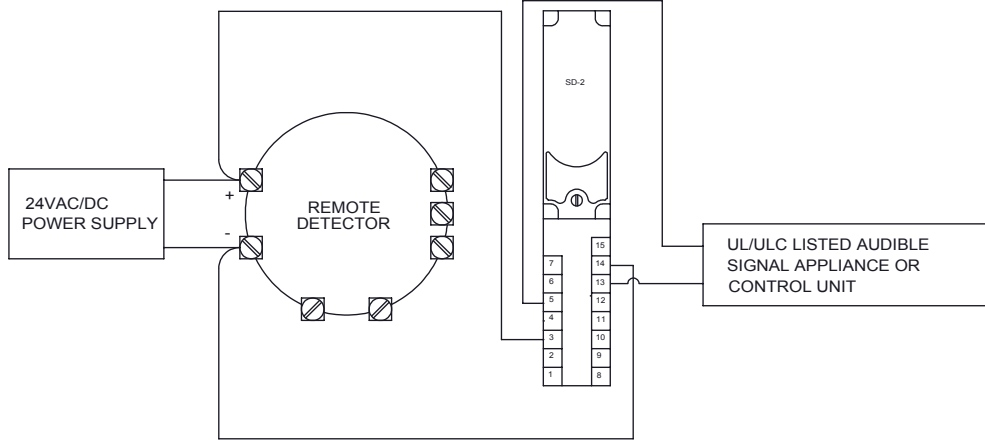

SD-2 DETECTOR TO AUDIBLE SIGNAL APPLIANCE

1. Connect terminals #5 & #13 of a singular unit directly to a UL/ULC listed audible signal appliance or alarm control panel.

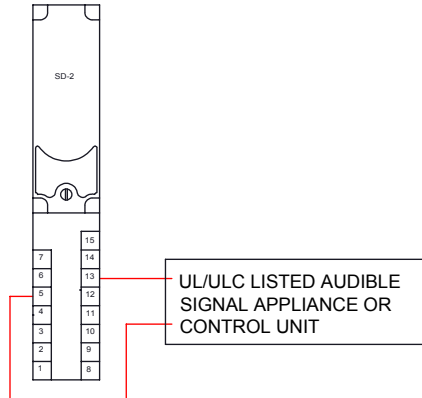

2. Installations with multiple units in a run must be connected to a UL/ULC listed audible signal appliance or alarm control panel as illustrated below.

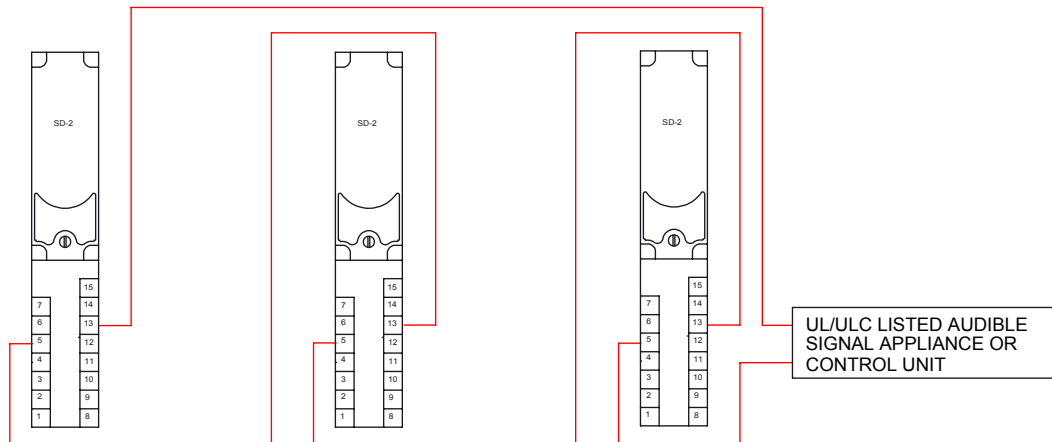

SD-2 DETECTOR TO REMOTE ALARM INDICATOR LAMP

Connect the positive wire of the remote alarm indicator lamp to terminal #8 of the detector module.
Connect the negative terminal of the indicator lamp to terminal #7 of the SD-2 detector.

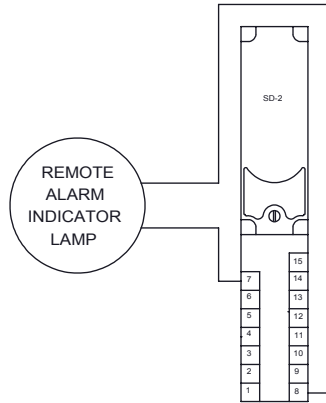

ALARM INITIATION WIRING (4 WIRE CLASS B & 6 WIRE CLASS A)

1. Make all connections as outlined previously for all units required by the job specifications.
2. Make all signal initiating connections as illustrated in the appropriate figure below. Note wiring differences for units with remote detectors vs. units without remote detectors. Dashed lines to return loop represent wires required for six (6) wire applications. These wires are omitted in four (4) wire applications.
3. Connections to only one (1) SD-2 are shown below.

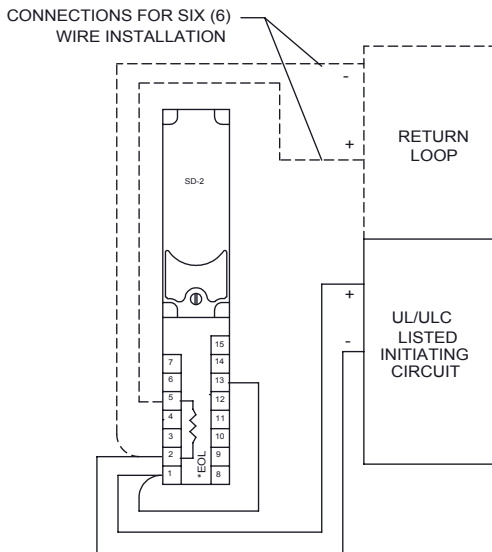

*EOL USED IN 4 WIRE APPLICATIONS ONLY

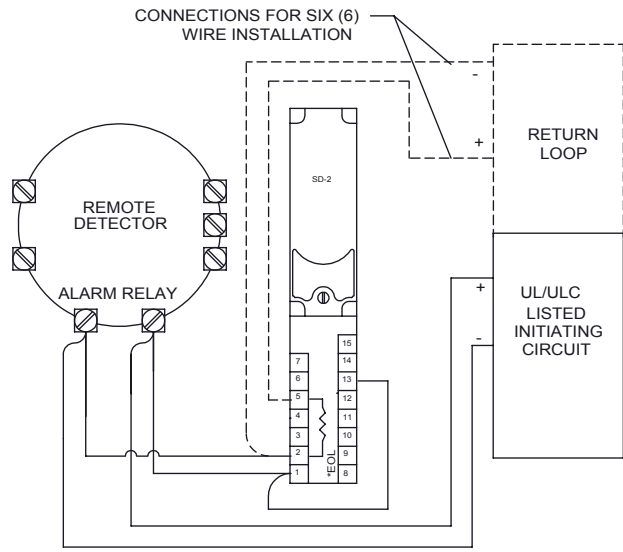

*EOL USED IN 4 WIRE APPLICATIONS ONLY

CONTINUED ON PAGE 11

ALARM INITIATION WIRING CONT.

4. Connections for two (2) SD-2 detectors would consist of detector (1) in figure below connected to detector (3) in the same manner as it is shown connected to detector (2). Detector (2) would be deleted.
5. More than three (3) SD-2 detectors are connected by inserting additional units with connections as shown for unit 2. The last unit in the run must be connected in the same manner as unit 3.

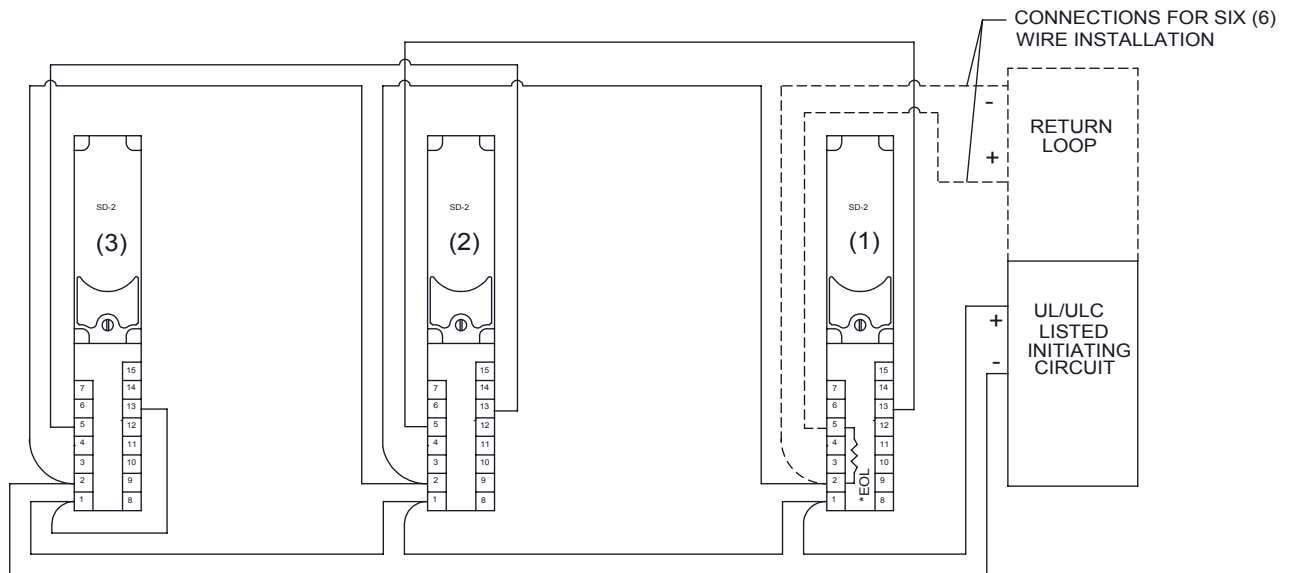

*EOL USED IN 4 WIRE APPLICATIONS ONLY

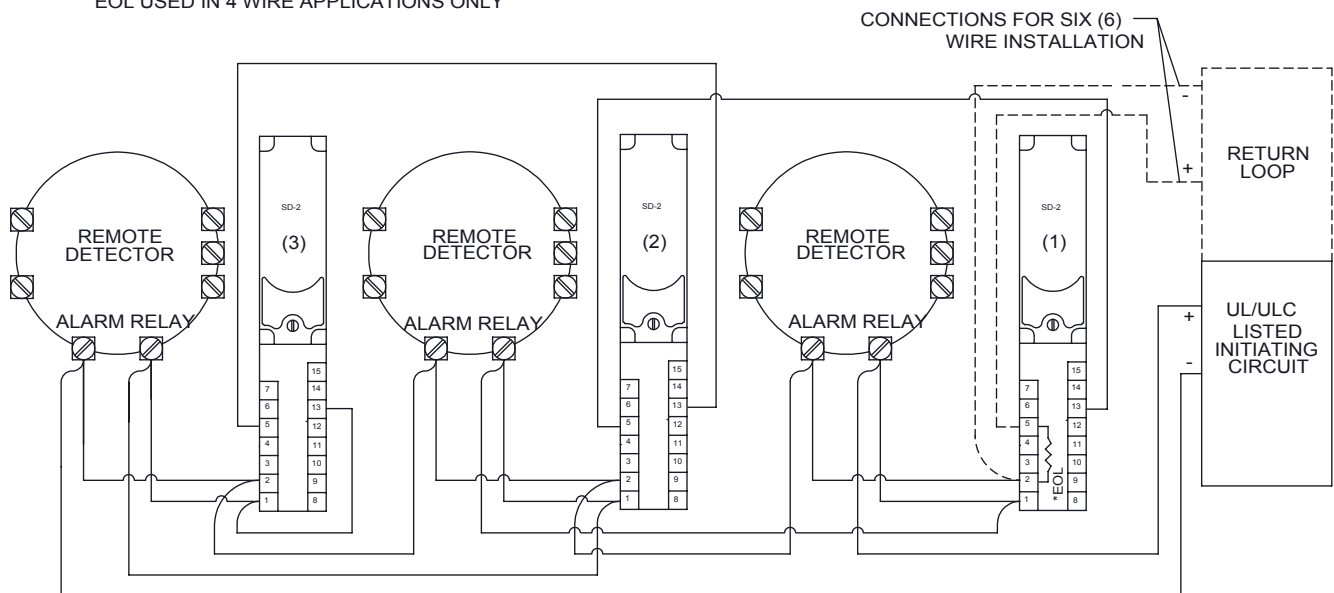

*EOL USED IN 4 WIRE APPLICATIONS ONLY

6. In four (4) wire installations, it is the responsibility of the installer to supply and connect the E.O.L. resistor specified by the fire alarm control panel used. The E.O.L. resistor is only installed in the first unit of the run as illustrated.

13 SD-2 DETECTOR SENSITIVITY TEST (ULC REQUIREMENT ONLY)

Voltage output terminals are provided to measure the sensitivity of the smoke detector. With power applied to the detector, connect a volt meter to the two test terminals. The normal range is between 1.27 - 3.38 Vdc.

SENSITIVITY TEST TERMINALS

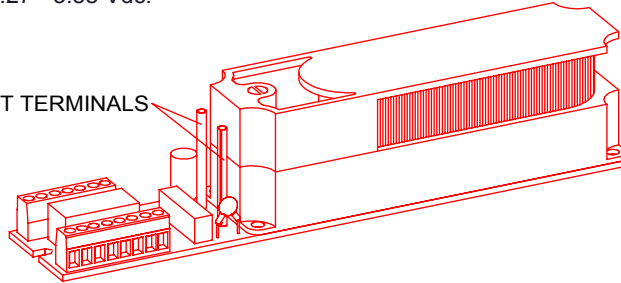

FINAL INSTALLATION AND TEST

14 Hold open position is preset at approximately 90°.

Loosen set screws using 3/32 inch hex wrench. Slide hold open device to desired position. Retighten set screws securely.

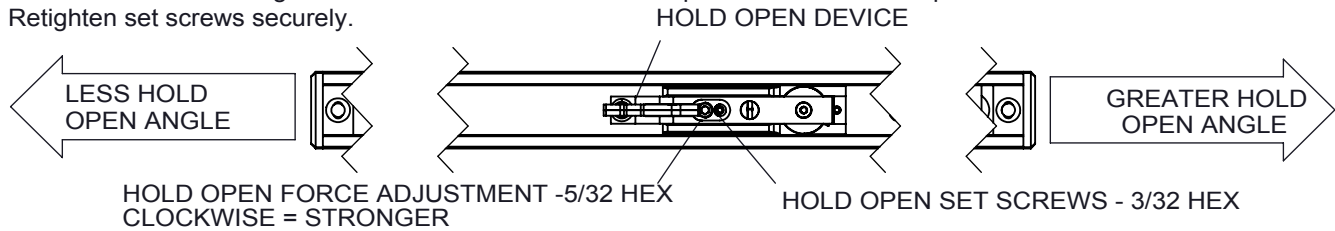

15 After installation is completed, check all connections. The LED will blink every seven (7) to ten (10) seconds to indicate the unit is operating properly.

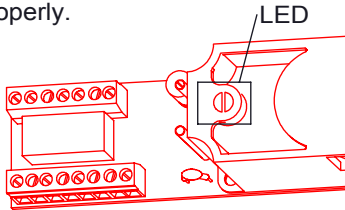

17 Turn light pipe clockwise to reset the detector. The LED will go off. Turn the light pipe to the normal position and the unit will resume blinking every seven (7) to ten (10) seconds to indicate that it is reset and functioning properly.

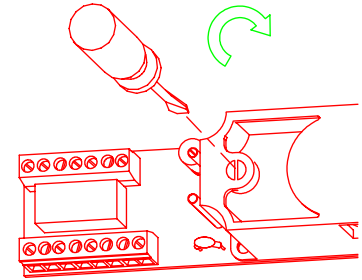

16 Open door so slide shoe engages with hold open assembly.

To test the detector, insert a small screwdriver into the slot in the light pipe of the detector. Turn counterclockwise and hold for ten seconds. The LED should remain continually red and allow the door to close.

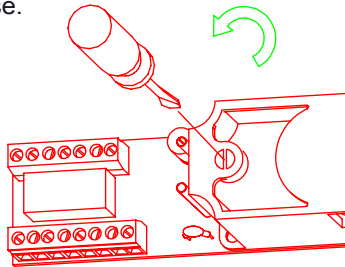

18 Install detector cover. Slide tab of cover under end of detector and rotate into possession. Insert (1) 4-40 screw and tighten.

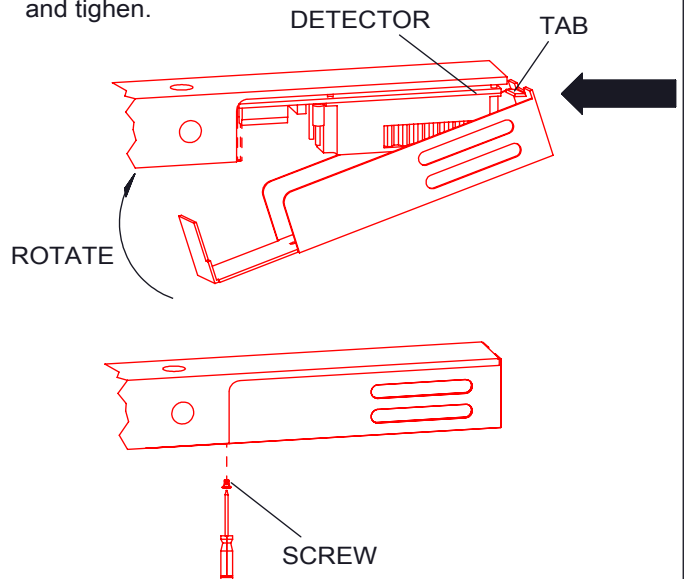

- 19 Place tab in cover slot opposite main arm.
Place cover over closer and fasten securely with screws provided.

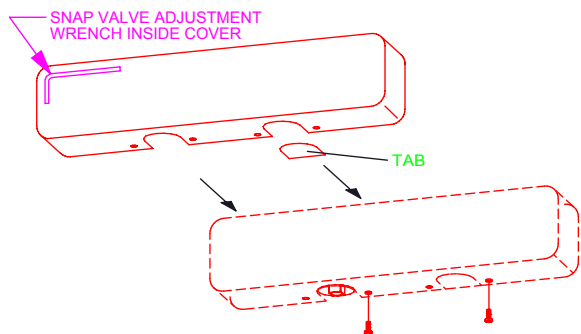

NOTE: LEFT HAND INSTALLATION SHOWN. RIGHT HAND IS A MIRROR IMAGE.

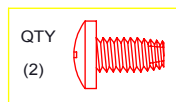

- 20 An auxiliary door stop (by others) must be installed to limit the maximum degree of door swing. Failure to do so may result in damage to the unit.

- 21 **IMPORTANT: THE UNIT MUST BE TESTED AFTER THE INSTALLATION, BY THE END USER, TO ASSURE THAT THE DOOR CLOSER UNITS FUNCTION PROPERLY WHEN THE ALARM SYSTEM IS ACTIVATED. THE ENTIRE SYSTEM MUST ALSO BE TESTED PERIODICALLY AFTER THE INITIAL INSTALLATION TEST, IN CONJUNCTION WITH THE TESTING OF THE FIRE ALARM SYSTEM. THE END USER IS ALSO RESPONSIBLE FOR THE ADJUSTMENTS AND MAINTENANCE TO RETAIN THE SYSTEM IN WORKING ORDER.**

1

Measure and record test voltage at test points RP1 & RP2. This voltage is a small signal, DC voltage. Set meter to the 2 volt scale.

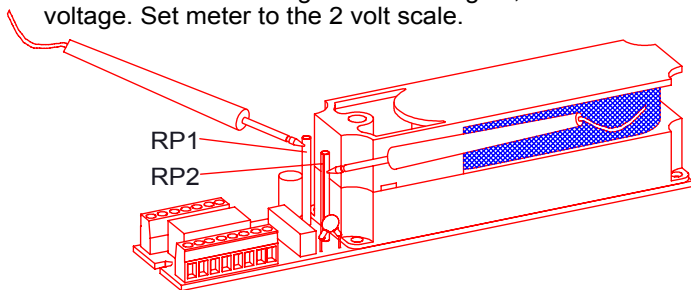

SD-2 DETECTOR MAINTENANCE

The SD-2 Detector has been designed to be as maintenance-free as possible. Normal air-borne dust, however, can accumulate in the detector sensing chamber and cause it to become more sensitive. All detectors must be tested and cleaned at least once a year. Detectors in dusty environments must be tested and cleaned more often. Detectors must also be tested and cleaned immediately after a fire. Failure to maintain detectors may result in needless false alarms.

2

First, vacuum or blow off any loose debris on outside of cover. Then, remove the detector cover and screen assembly by rotating a flat screwdriver in slot (both sides) and pulling it straight up. Cover may be difficult to remove the first time.

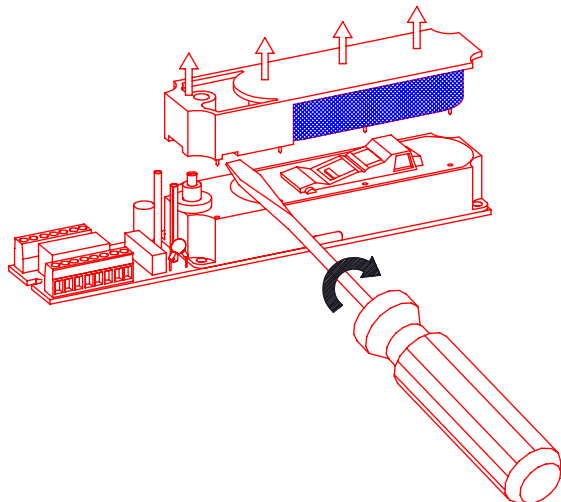

3

Vacuum all areas illustrated below, and then blow off same areas with compressed air. Before reassembling the detector, be sure all parts are free of debris.

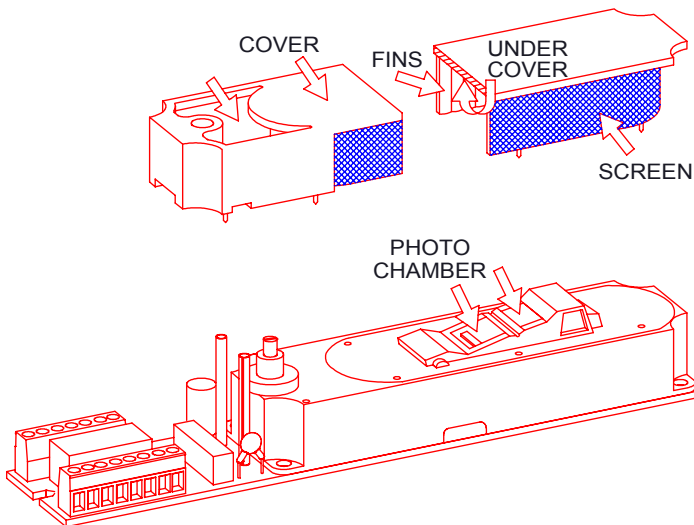

4	Replace cover and screen assembly.	
5	Measure and record test voltage at test points RP1 & RP2. If the product is operating normally, and was cleaned effectively, the test voltage will be less than the voltage recorded earlier. (Typical voltage for a clean device is .9 - 1.58 Vdc.)	

SMOKE DETECTOR TESTING

Point the Smoke Detector Tester tube at the detector and release a burst of aerosol by depressing the nozzle for 1 second. Give the detector sufficient time to respond. This may be up to 20 seconds.

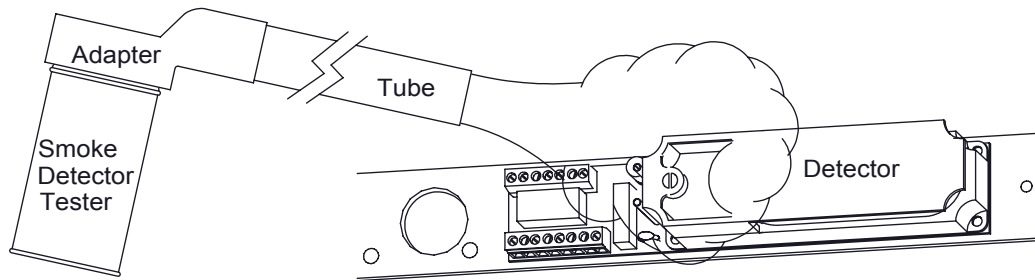

If the detector is in an area where air velocities exceed 100 feet/minute, the detector may not alarm on the first try. This could be due to the signal processing feature of the detector. Signal processing is a feature that adds a time delay to each detector which effectively increases its stability. If this is the case, spray in repeated bursts of 1 second at approximately 5 to 10 second intervals. The total number of sprays should not exceed five (5). If the detector does not alarm after 5 consecutive sprays, it will be necessary to generate larger volumes of smoke to overcome the air flow dilution factor. This can be accomplished by burning paper or fabric in a metal can.

DORMA accepts the use of Home Safeguard Smoke Detector Tester (Models 1H and 25S) if, and only if, it is used:

1. with the Model 1490 Accessory.
2. with the new formula aerosol as identified by a date code, located on the bottom of the can, of 1990 or later. (This date code can be read as first numeral = last digit of year so that a B0xxx = 1990 and B9xxx = 1989.)
3. in accordance with the instructions stated above.

If the preceding requirements are not met, the use of Smoke Detector Tester is unacceptable and DORMA cannot guarantee the proper operation of detectors that have been subjected to this product.

Alternative methods of generating smoke/aerosol such as the Gemini 501 Smoke Generator Machine may be used to cause alarm at the detector's installed location. Set the generator to represent a 4%/ft to 5%/ft obscuration as described in the Gemini 501 Manual and apply aerosol until the unit alarms. If the Gemini unit is not available, cigarette, punk, or cotton wick are also acceptable means of generating smoke to test this detector.

REMEMBER:

Aerosol testing is only a "go - no go" test and is not an acceptable means to determine the smoke detector's sensitivity. See NFPA 72E.

HOME SAFEGUARD INDUSTRIES
800-822-5676
FAX (847) 427-8343
107 Garlisch Drive
Elk Grove, IL 60007